

X-Station 2

設置ガイド

バージョン 1.02

日本語

JA 101.00.XS2-ODPB, XS2-OAPB V1.02

目次

安全にお使いいただくために	2	製品仕様	21
指示アイコン	2	寸法	23
はじめに	5	FCC 準拠情報	24
部品	5	EU 適合宣言 (CE)	24
各部品の名前と機能	6	付録	25
ケーブルとコネクタ	7	免責事項	25
指紋を登録する方法	8	著作権表示	25
QR/バーコードの使用方法およびデバイス ライセンスに関する注記	9	オープンソースライセンス	25
QR/バーコードのスキャン方法	9	GNU General Public License	26
デバイスライセンスに関する注記	9	TERMS AND CONDITIONS	26
設置場所	10	BoringSSL License	33
ブラケットと製品の固定	10	OpenSSL License	33
電源装置の接続	12	Original SSLeay License	34
ネットワーク接続	13	Licenses for support code	35
TCP/IP	13	Apache License	36
TTL 入力接続	14		
リレー接続	15		
フェールセーフロック	15		
フェールセキュアロック	16		
自動ドア接続	17		
スタンドアロンでの接続	18		
Secure I/O 2 への接続	19		
Wiegand 接続	20		

安全にお使いいただくために

本製品を使用する前に、ご自身や他人への怪我を未然に防ぎ、物的損害を防止するために、この「安全にお使いいただくために」をお読みください。本マニュアルの「製品」という用語は、製品および製品に付属するすべての品目を指します。

指示アイコン



警告:この記号は、死亡または重傷につながるおそれのある状況を示しています。



注意:この記号は、中度の傷害や物的損害をもたらすおそれのある状況を示しています。



注意:この記号は、注記または追加情報を示します。



警告

設置場所

大容量電源を使用する場合は、誤配線に特に注意してください。

- 配線を誤ると、重大な火災、感電、または製品の損傷を引き起こす恐れがあります。

本製品を無断で設置したり修理したりしないでください。

- 感電、火災、または製品の損傷につながるおそれがあります。
- あらゆる改造により、または取り付け手順に従わなかったために損傷が生じた場合は、製造元の保証が無効になることがあります。

本製品を、直射日光の当たる場所、湿気の多い場所、埃やすすの多い場所、ガス漏れがありそうな場所には置かないでください。

- 感電または火災につながるおそれがあります。

本製品を屋外に設置する場合は、過熱を防ぐために、直射日光の当たらない、風通しが良い涼しい場所に設置してください。

本製品を屋外に設置する際、密閉されたエンクロージャの中には入れないでください。

エンクロージャの内部温度が上昇すると、感電、火災、または故障につながるおそれがあります。

本製品を、熱器具の近くなど高温になる場所に置かないでください。

- 過熱により火災につながるおそれがあります。

本製品を、乾燥した場所に設置してください。

- 湿気や液体は感電や製品の損傷につながるおそれがあります。

本製品を、無線周波数の影響を受ける場所に設置しないでください。

- 火災や製品の損傷につながるおそれがあります。

お取り扱い

本製品は乾燥した状態にしておいてください。

- 湿気や液体は感電、火災、または製品の損傷につながるおそれがあります。

損傷した電源アダプタ、プラグ、緩んだコンセントは使用しないでください。

- 接続部がしっかりと固定されていないと、感電や火災の原因になるおそれがあります。

電源コードを折り曲げたり損傷させたりしないでください。

- 感電または火災につながるおそれがあります。



注意

設置場所

製品を設置する前にこのマニュアルをお読みにになり、安全で正しい設置を行うようにしてください。

電源ケーブルやその他のケーブルを配線するときは、すべてのデバイスの電源を切った状態で接続してください。

- 本製品が故障する恐れがあります。

マニュアルをダブルチェックして、正しく配線されていることを確認してから、製品に電源を接続してください。

本製品を、直射日光や紫外線が当たる場所に設置しないでください。

- 製品の損傷、故障、変色、変形につながるおそれがあります。

電源ケーブルを人が通る場所に取り付けしないでください。

- 負傷や製品の損傷につながるおそれがあります。

本製品を、磁石、テレビ、モニター（特に CRT モニター）、スピーカーなど磁気を発する物の近くに設置しないでください。

- 本製品が故障するおそれがあります。

複数の製品を設置する場合は、製品の間には最低限の間隔を空けてください。

- 本製品が他の製品から放射される無線周波数の影響を受けて、故障するおそれがあります。

IEC/EN 62368-1 の認可を受けた、製品の電力消費量以上に対応する電源アダプタを使用してください。Suprema が販売する電源アダプタを使用することを強くお勧めします。

- 適切な電源を使用しないと、本製品が正しく動作しない恐れがあります。
- 最大消費電流の仕様については、製品仕様の電源を参照してください。

Secure I/O 2、電子ロック、および本製品に対して、独立した電源を使用してください。

- 同じ電源を接続して使用すると、本製品が誤動作するおそれがあります。

電源と Power over Ethernet (PoE) を同時に接続して使用しないでください。

- 本製品が故障するおそれがあります。

IP65等級を満足するために、製品とケーブルを接続した後、必ず、配線カバーか配管を使用、筐体に収納することをすることをお勧めします。

- 防水・防塵性能が低下すると故障の原因となります。



注意

お取り扱い

本製品を落下させたり、衝撃を与えたりしないでください。

- 本製品が故障するおそれがあります。

製品のファームウェアのアップグレードが進行中の電源供給が中断されないように注意してください。

- 本製品が故障するおそれがあります。

パスワードを他人に開示しないでください。また、定期的に変更してください。

- そうしないと、不正な侵入が発生するおそれがあります。

本製品のボタンを無理に押ししたり、鋭利な工具で押ししたりしないでください。

- 本製品が故障するおそれがあります。

本製品を非常に高温または低温になる場所に保管しないでください。本製品は -20°C ～ 50°C の温度で使用することをお勧めします。

- 本製品が故障するおそれがあります。

本製品を清掃する際は、次の点に注意してください。

- 清潔で乾燥したタオルで本製品を拭きます。
- 本製品を消毒する必要がある場合は、布またはティッシュを適量の消毒用アルコールで湿らせ、指紋センサーなどの露出した表面をすべて丁寧に清掃します。消毒用アルコール(イソプロピルアルコール含有率 70%)と、清潔で研磨性のない布(レンズ用ティッシュなど)を使用します。
- 本製品の表面に液体を直接塗布しないでください。

本製品を本来の用途以外に使用しないでください。

- 本製品が故障するおそれがあります。

RTC バッテリー

承認を受けていない、または正しくないタイプのバッテリーを使用すると、爆発のおそれがあります。バッテリーの廃棄は、該当する地域または国際的な廃棄物規制に従ってください。

はじめに

部品

			
X-Station 2	壁用ブラケット	穴あけ用テンプレート	
			
接続ケーブル	ダイオード	120 Ω 抵抗	
			
PVC アンカー x 2	固定ねじ x 2	ブラケット固定ねじ (星形)	
			
ケーブルカバー	収縮チューブ	クイックガイド	オープンソースの ソフトウェアガイド



- 部品は設置環境によって異なる場合があります。
- 製品をブラケットに組み付ける際、セキュリティを強化するために、製品固定ねじの代わりに付属のブラケット固定ねじ(星形)を使用できます。
- 製品の詳細については、Suprema のウェブサイト(<https://www.supremainc.com>)にアクセスして、ユーザーガイドを参照してください。

各部品の名前と機能

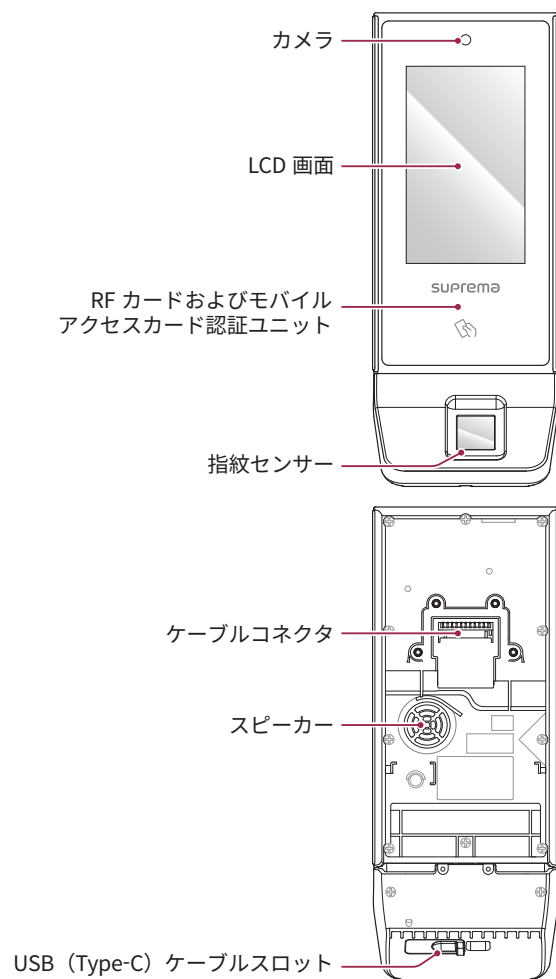

名前	説明
カメラ	ユーザーの写真の登録及びイメージログを取得します。
LCD 画面	操作用の UI があります。
RF カードおよびモバイルアクセスカード認証ユニット	エントランス用の RFID カードまたはモバイルアクセスカードをスキャンする部分。
指紋センサー	指紋を読み取ります。
ケーブルコネクタ	ケーブルを接続します。 <ul style="list-style-type: none"> 電源装置 イーサネット + PoE RS-485 Wiegand 入力および出力 TTL 入力 リレー
スピーカー	音を鳴らします。
USB (Type-C) ケーブルスロット	USB ケーブルを接続します。

ケーブルとコネクタ

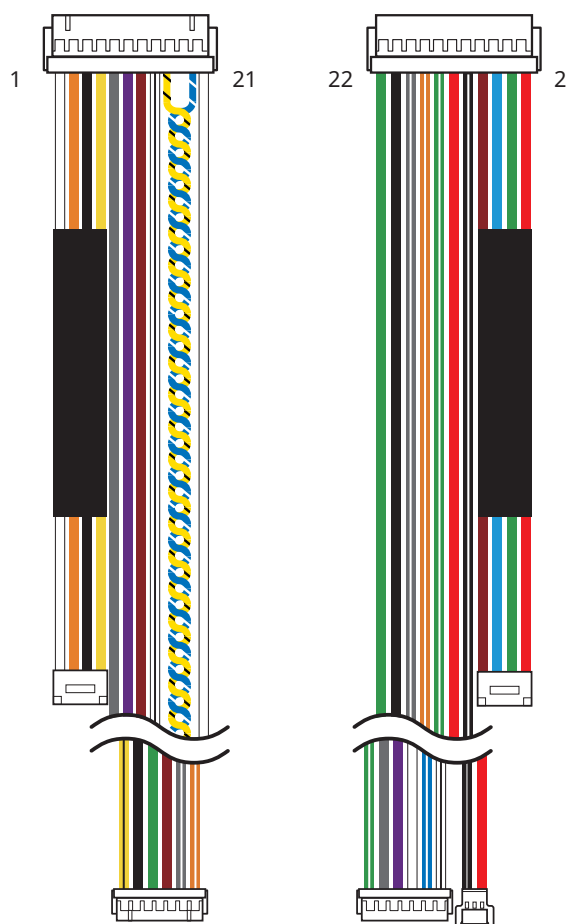

ケーブル	PIN	名前	色
RJ-45 (イーサネット + PoE)	1	ENET TXP	白
	3	ENET TXN	オレンジ
	5	ENET RXP	黒
	7	ENET RXN	黄
TTL 入力	9	TTL GND	グレー
	11	TTL IN0	紫
	13	TTL IN1	茶
RS-485	15	485 GND	白(黒のストライプ)
	17	485 TRXN	黄(黒のストライプ)
	19	485 TRXP	青(白のストライプ)
Wiegand	21	WG D1	白
	22	WG D0	緑
	20	WG GND	黒
リレー	18	RLY NO	グレー(白のストライプ)
	16	RLY NC	オレンジ(白のストライプ)
	14	RLY COM	緑(白のストライプ)
電源	12	PWR +VDC	赤
	10	PWR GND	黒(白のストライプ)
RJ-45 (イーサネット + PoE)	8	VB2	茶
	6	VB2	青
	4	VB1	緑
	2	VB1	赤

指紋を登録する方法

指紋の認証率を上げるために、指紋を正しく登録してください。X-Station 2 では、ユーザーの指紋入力角度と位置が変化しても指紋を認識できます。指紋を登録する際に次の点に注意すると、認証率が上がる場合があります。

指紋を入力する指を選ぶ

- 特定の指の指紋を使用できない場合、例えば片手で荷物を持ち上げていたり、指に怪我をしていたりする場合に備えて、ユーザーごとに最大 10 個の指紋を登録できます。
- 指紋がうまく認識されない場合は、2 回連続して同じ指で登録すると認証率が上がる場合があります。
- 指に切り傷がある場合や、指紋がはっきりしない場合は、別の指の指紋を登録します。
- 指紋をスキャンする際に人差し指または中指を使用することを推奨します。指紋センサーの中央に別の指を正確に置くことが難しい場合は、認証率が低下する場合があります。

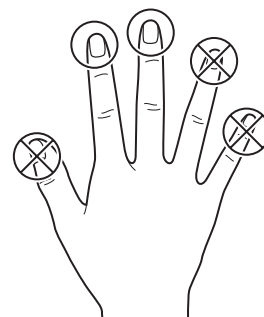

指紋の登録方法

- 1 指紋の登録用の LCD 画面に「Scan Finger (スキャンフィンガー)」というメッセージが表示されたら、指紋を登録する指を指紋認証ユニットに置き、認証率を上げるために指を軽く押し付けます。



- 2 ビープ音の後に再入力画面が表示されたら、登録した指の指紋を再度スキャンします (登録する指の指紋を 2 回スキャンします)。



指紋の登録に関する注意

指紋認識時には最初に登録した指紋と照合されるため、最初の指紋登録が最も重要です。指紋を登録する際は次の点に注意してください。

- 指をセンサーに密着させてしっかりと押し付けます。
- 指紋の中央をセンサーの中央に合わせてください。
- 指に切り傷がある場合や、指紋がはっきりしない場合は、別の指の指紋を登録します。
- 画面の指示に従って、指を動かさずに指紋を正しくスキャンします。
- 指を動かしてセンサーとの接触面が小さくなったり指の角度が変わったりすると、指紋認証が行われない場合があります。



指紋認識が失敗した場合

X-Station 2 は、季節の変化や指の状態にかかわらず、指紋を認識できます。ただし、認証率は、外部環境や指紋入力方法によって異なる場合があります。指紋認証がスムーズにいかない場合は、以下の措置を講じることをお勧めします。

- 指が水や汗で濡れている場合は、指を乾かしてからスキャンします。
- 指が乾燥し過ぎている場合は、指先に息を当ててから指をスキャンします。
- 指を切った場合は、別の指の指紋を登録します。
- 最初に登録した指紋が正しくスキャンされていない場合があるため、「指紋の登録に関する注意」に従って、もう一度指紋を登録してください。

QR/バーコードの使用方法およびデバイスライセンスに関する注記

QR/バーコードをユーザーに発行し、認証方法として使用できます。QR/バーコードの認識率を高めるために、画面の指示に従って正しくスキャンしてください。

QR/バーコードのスキャン方法

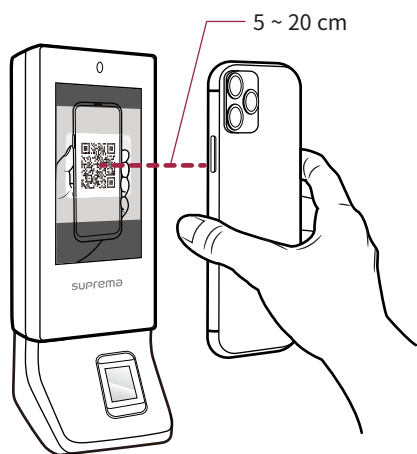

- デバイスのカメラと QR/バーコードの間隔を 5~20 cm に保ちます。
- QR/バーコードをデバイスのスキャン画面の中央に配置します。
- スマートフォンにダウンロードした QR/バーコードを使用して認証を行う場合、デバイスが QR/バーコードをはっきり読み取れるようにスマートフォンの輝度を調整します。
- 画面の指示に従わない場合、QR/バーコードのスキャンに時間がかかったり、スキャンに失敗したりすることがあります。

デバイスライセンスに関する注記

- QR/バーコード認証を使用するには、別途デバイスライセンスが必要です。デバイスライセンスを発行するには、購入先にご連絡ください。
- デバイスライセンスファイルは暗号化されたファイルであるため、自由に変更することはできません。
- デバイスライセンスは、デバイス ID に基づいて発行されます。デバイス ID が通常とは異なる方法で変更された場合、ライセンスの保証サービスは提供されません。

設置場所

ブラケットと製品の固定

- 1 付属のドリル用テンプレートを使用して、ブラケットを取り付ける正しい位置を決定します。固定ねじをブラケットに通して、X-Station 2 の取り付け位置にブラケットをしっかりと固定します。

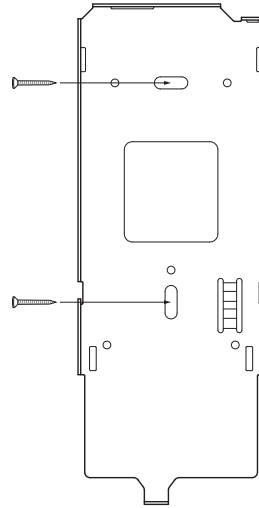

- コンクリート壁に X-Station 2 を設置する場合は、ドリルで穴を開け、PVC アンカーを挿入して、固定ねじで固定します。
- RF 干渉を回避するには、最小分離距離を維持する必要があります。

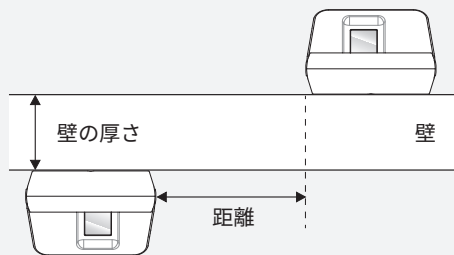

壁の厚さ	距離
100 mm	500 mm
120 mm	400 mm
150 mm	300 mm

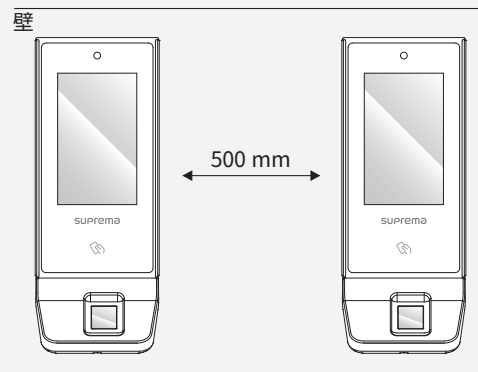

- モバイルアクセスカードを使用するときは、RF 干渉を回避するために、各デバイスを 1 m 以上離して設置します。

2 ケーブルカバーを組み付け、X-Station 2 を固定ブラケットに取り付けます。

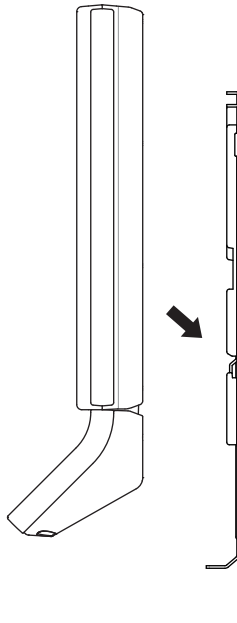

3 X-Station 2 の製品固定ねじを締めて、X-Station 2 をブラケットに接合します。

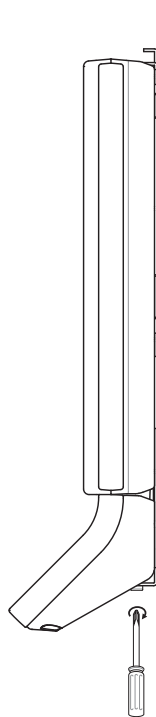

電源装置の接続

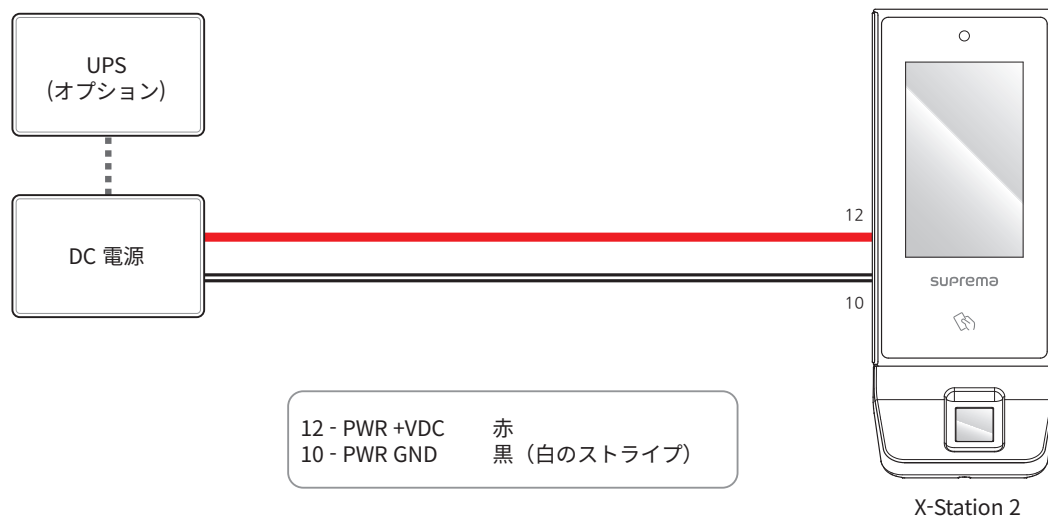

- IEC/EN 62368-1 の認可を受けた、製品の電力消費量以上に対応する電源アダプタを使用してください。別のデバイスを電源アダプタに接続して使用する場合は、端末と別のデバイスに必要な合計の電力消費量以上の電流容量を備えたアダプタを使用してください。
 - 最大消費電流の仕様については、製品仕様の**電源**を参照してください。
- 電源アダプタを使用する場合は、電源ケーブルの長さを延長しないでください。
- Secure I/O 2、電子ロック、および製品ごとに独立した電源を使用してください。これらのデバイスを同じ電源に接続して使用すると、デバイスが正常に機能しない場合があります。
- デバイスを DC 電源 (またはアダプタ) と PoE 電源の両方に同時に接続しないでください。

ネットワーク接続

TCP/IP

LAN 接続(ハブに接続)

一般的なタイプの CAT-5 ケーブルを使用して、製品をハブに接続できます。

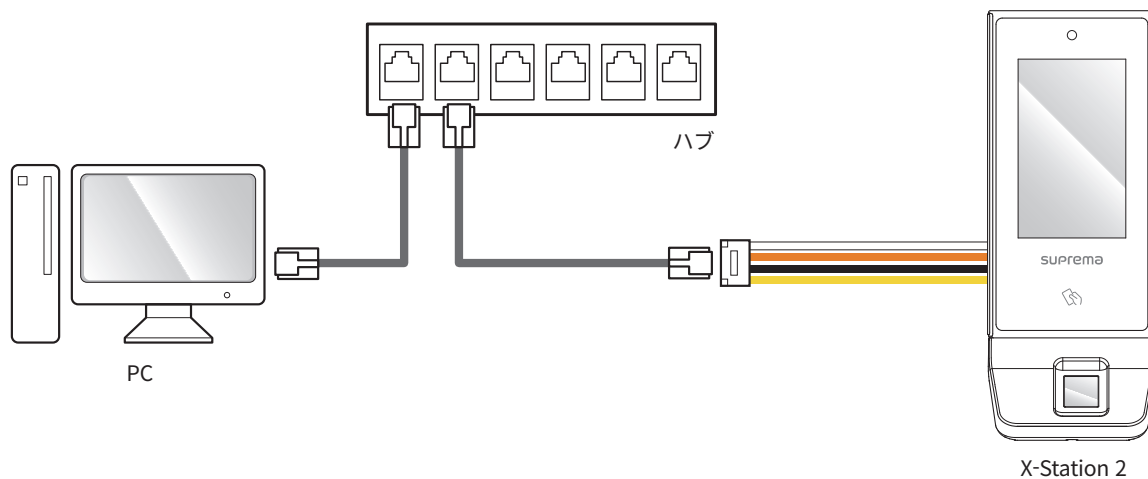

LAN 接続(PC への直接接続)

X-Station 2 には、通常のストレートタイプの CAT-5 ケーブルまたはクロスケーブルを使用して直接 PC に接続できるように、自動 MDI/MDIX 機能が搭載されています。

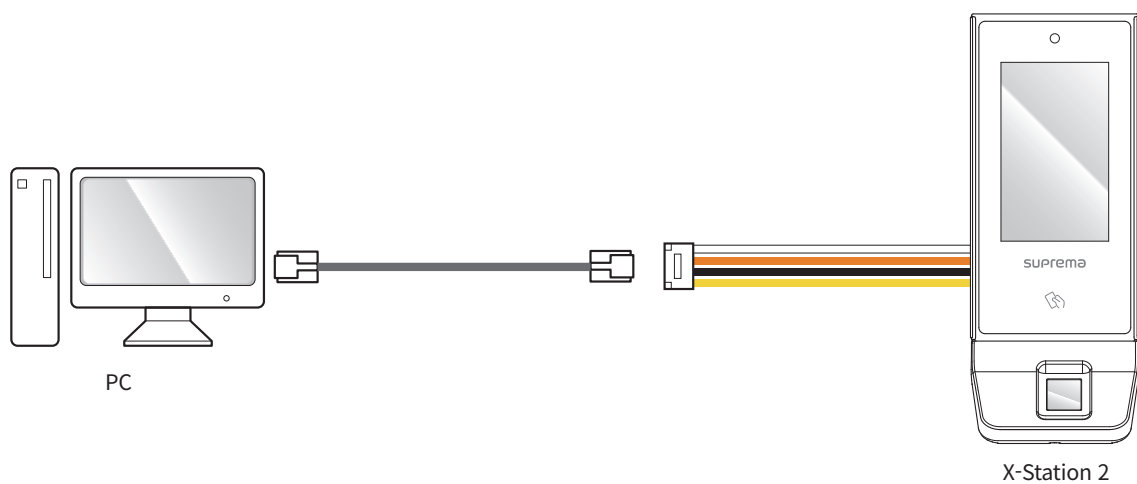

TTL 入力接続

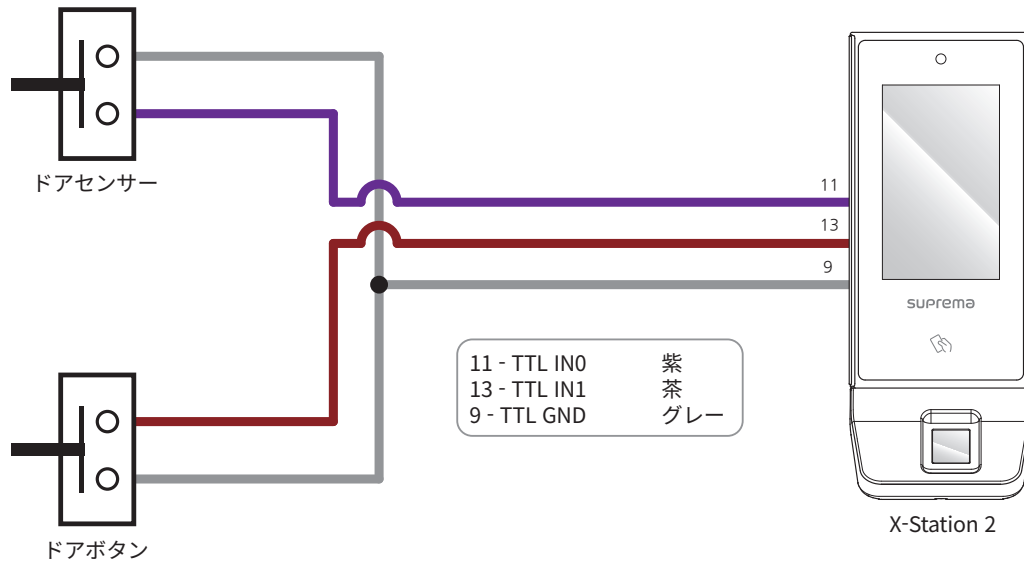

リレー接続

フェールセーフロック

フェールセーフロックを使用するために、下の図のように N/C リレーを接続します。通常、フェールセーフロック用のリレーには電流が流れています。リレーが作動して電流が遮断されると、ドアが開きます。停電や外部の要因のために製品に接続した電源が切断された場合は、ドアが開きます。

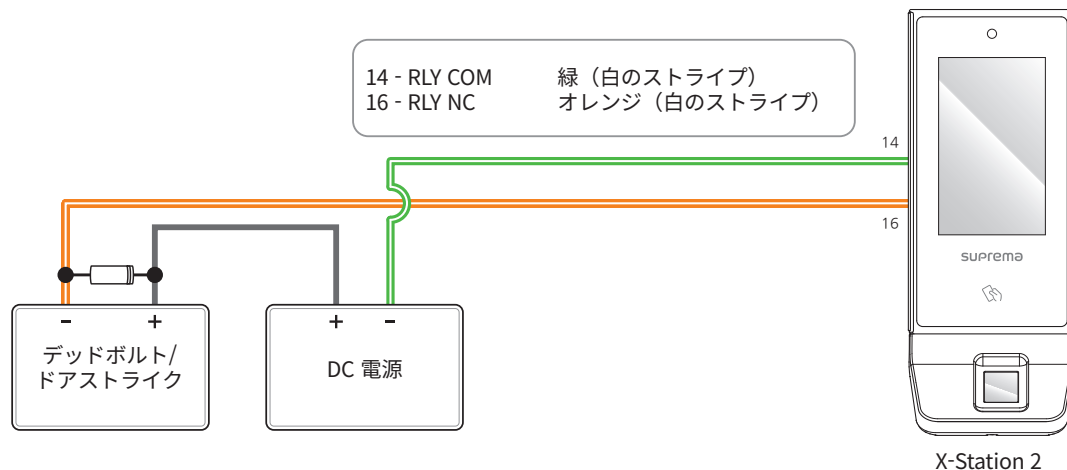

- 図のようにドアロックワイヤーの両側にダイオードを取り付けて、ドアロックの作動時に発生する逆電流からリレーを保護します。
- X-Station 2 とドアロックには別々の電源を使用してください。
- Suprema のスタンドアロン型インテリジェントリーダーには、外部コントローラなしでドアを直接ロック/ロック解除できる内部リレーが搭載されており、利便性が向上しています。ただし、セキュリティを必要とする入退管理の用途では、ドアのロック解除を引き起こす可能性のある改ざん攻撃を防止するため、リーダーの内部リレーの使用はお勧めしません。このような用途では、ドアの安全な側に設置された Suprema の Secure I/O 2、DM-20、CoreStation などのロックコントロールには個別のリレーユニットを使用することを強くお勧めします。



- ダイオードの取り付け方向に注意してください。ダイオードはドアロックの近くに取り付けます。

フェールセキュアロック

フェールセキュアロックを使用するには、下の図のように N/O リレーを接続します。通常、フェールセキュアロック用のリレーに電流は流れていません。電流がリレーによって作動すると、ドアが開きます。停電や外部の要因のために、製品に接続した電源が切断された場合は、ドアがロックします。

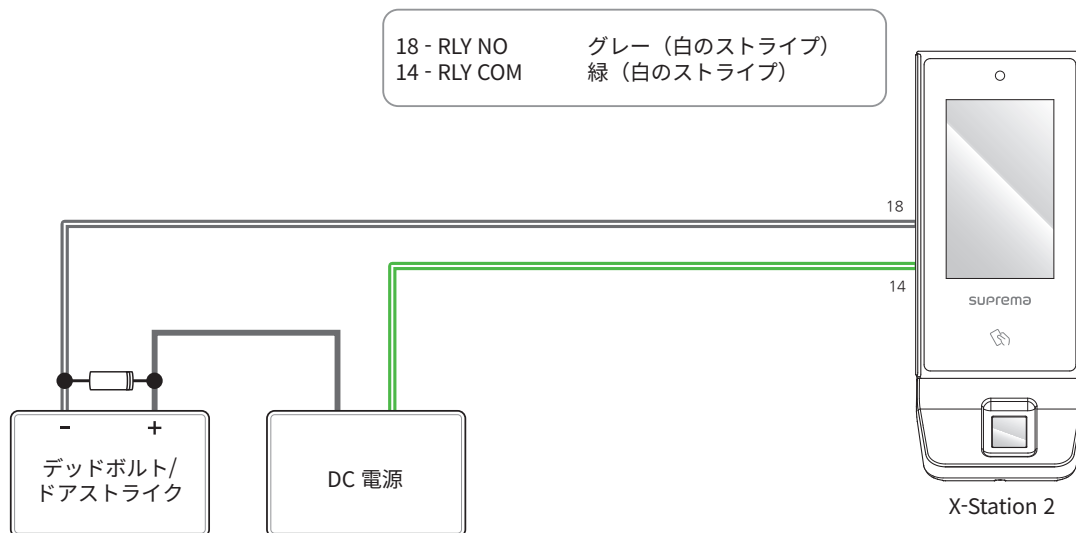

- 図のようにドアロックワイヤーの両側にダイオードを取り付けて、ドアロックの作動時に発生する逆電流からリレーを保護します。
- X-Station 2 とドアロックには別々の電源を使用してください。
- Suprema のスタンドアロン型インテリジェントリーダーには、外部コントローラなしでドアを直接ロック/ロック解除できる内部リレーが搭載されており、利便性が向上しています。ただし、セキュリティを必要とする入退管理の用途では、ドアのロック解除を引き起こす可能性のある改ざん攻撃を防止するため、リーダーの内部リレーの使用はお勧めしません。このような用途では、ドアの安全な側に設置された Suprema の Secure I/O 2、DM-20、CoreStation などのロックコントロールには個別のリレーユニットを使用することを強くお勧めします。



- ダイオードの取り付け方向に注意してください。ダイオードはドアロックの近くに取り付けます。

自動ドア接続

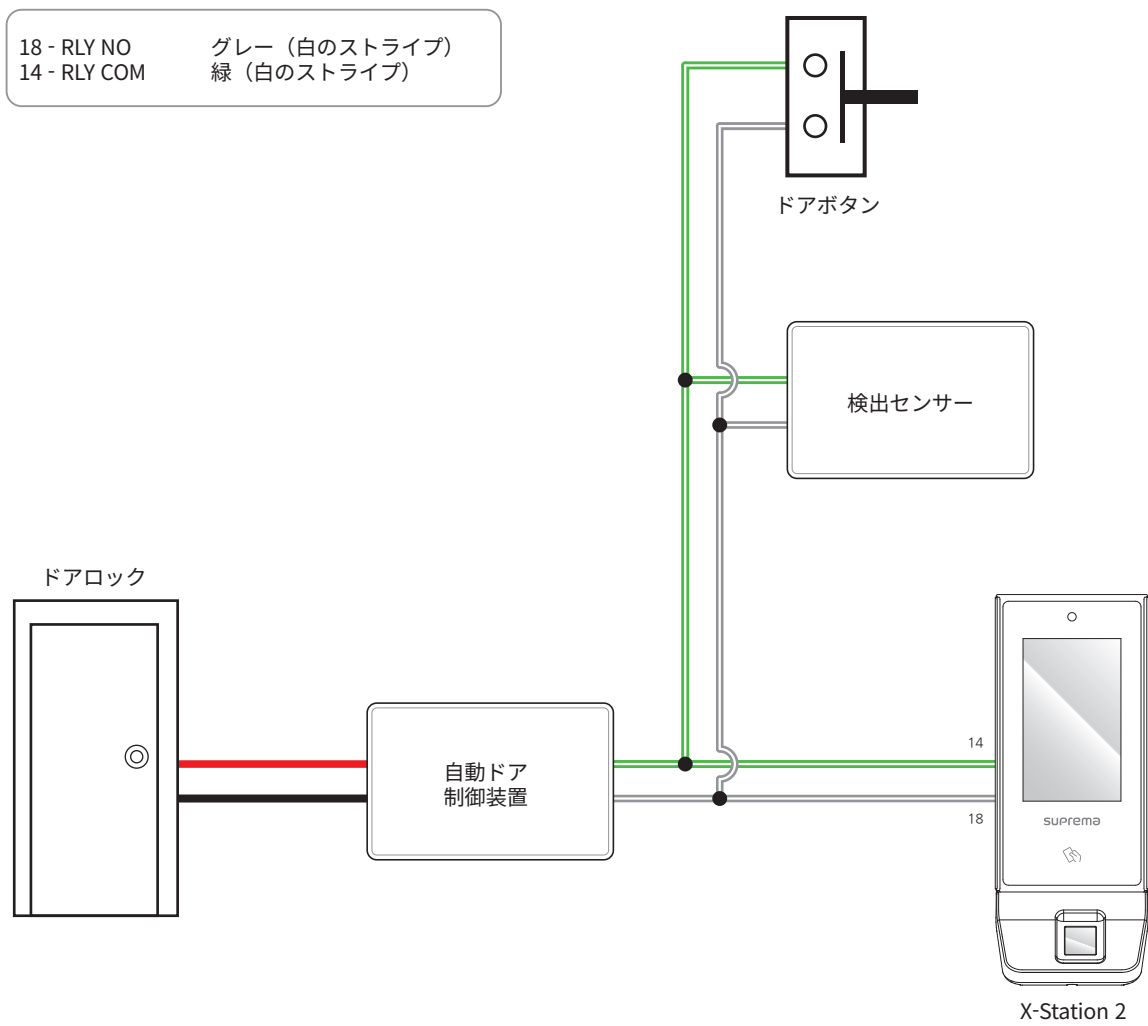

スタンドアロンでの接続

X-Station 2 は、個別の I/O デバイスを接続せずにドアロック、ドアボタン、およびドアセンサーに直接接続できます。

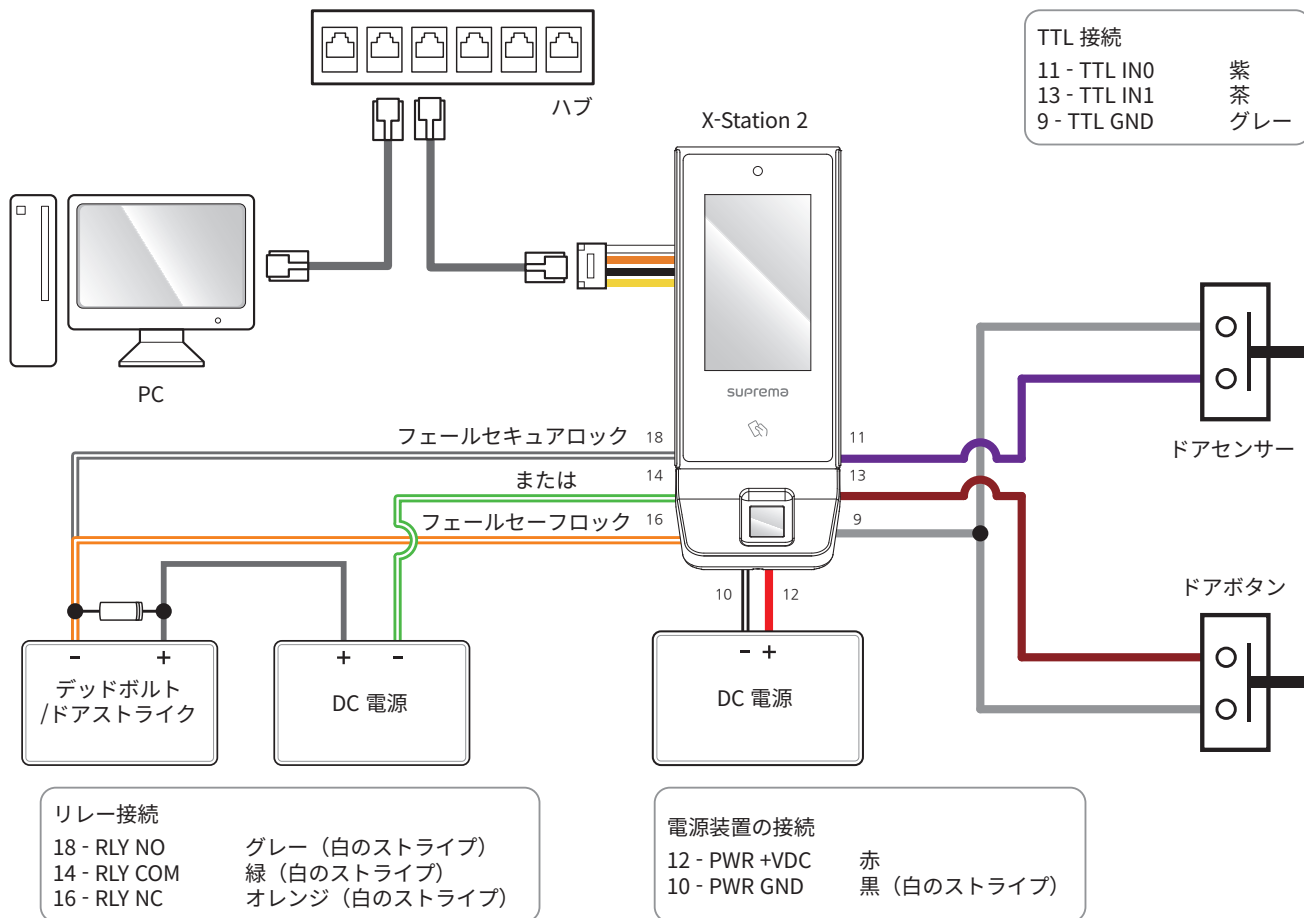

- Suprema のスタンドアロン型インテリジェントリーダーには、外部コントローラなしでドアを直接ロック/ロック解除できる内部リレーが搭載されており、利便性が向上しています。ただし、セキュリティを必要とする入退管理の用途では、ドアのロック解除を引き起こす可能性のある改ざん攻撃を防止するため、リーダーの内部リレーの使用はお勧めしません。このような用途では、ドアの安全な側に設置された Suprema の Secure I/O 2、DM-20、CoreStation などのロックコントロールには個別のリレーユニットを使用することを強くお勧めします。



- X-Station 2 は、RS485 ケーブルでスレーブデバイスと接続したマルチドアコントローラとして使用できます。スレーブデバイスはダミーリーダーとして使用され、認証はマスターデバイスで実行されます。
- 詳細については、Suprema 技術サポートチーム (support.supremainc.com) にお問い合わせください。

Secure I/O 2 への接続

Secure I/O 2 は、RS-485 ケーブルで X-Station 2 に接続できる I/O デバイスです。X-Station 2 と Secure I/O 2 の間の接続が失われたり、外部要因により X-Station 2 への電源が切断されたりしても、セキュリティを維持できます。

- RS-485 ケーブルには、最大長が 1.2 km の AWG 24 ツイストペアを使用します。
- RS-485 のデジチェーンで接続する場合は、デジチェーン接続の両端に終端抵抗 (120 Ω) を接続してください。中央の線に接続すると、信号レベルが小さくなり、通信性能が低下します。必ずデジチェーン接続の両端に接続してください。

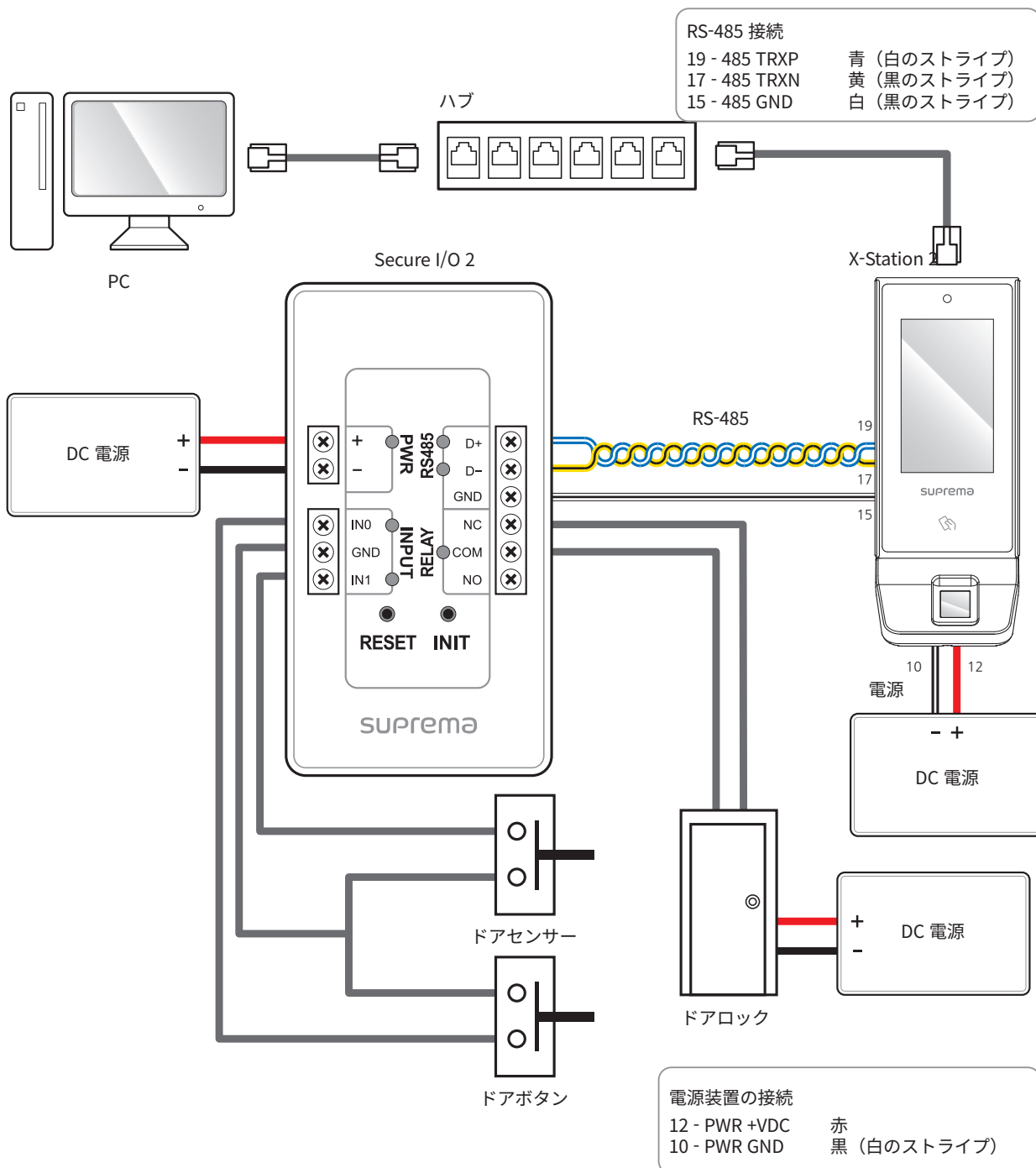

- X-Station 2 は、RS485 ケーブルでスレーブデバイスと接続したマルチドアコントローラとして使用できます。スレーブデバイスはダミーリーダーとして使用され、認証はマスターデバイスで実行されます。
- 詳細については、Suprema 技術サポートチーム (support.supremainc.com) にお問い合わせください。

Wiegand 接続

Wiegand 入力または出力デバイスとして使用

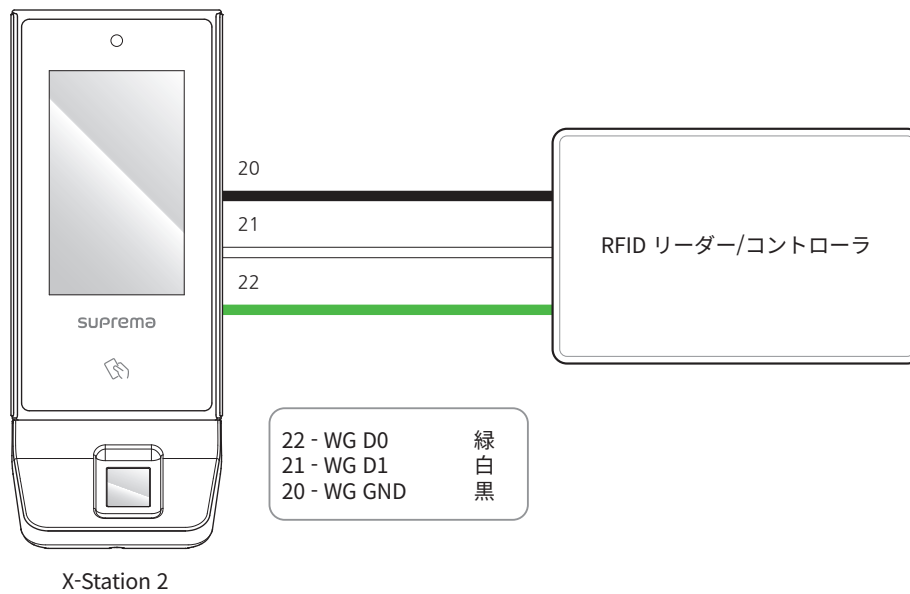

製品仕様

カテゴリ	機能	仕様
認証情報	RF オプション	<ul style="list-style-type: none"> • XS2-ODPB: 125kHz EM & 13.56MHz MIFARE、MIFARE Plus、DESFire、DESFire EV1/EV2/EV3¹⁾、FeliCa • XS2-OAPB: 125kHz EM、HID Prox & 13.56MHz MIFARE、MIFARE Plus、DESFire、DESFire EV1/EV2/EV3¹⁾、FeliCa、iCLASS SE/SR/Seos
	RF 読み取り範囲 ²⁾	EM/HID Prox/MIFARE/DESFire/HID iCLASS:50 mm、Felica:30 mm
	モバイル	NFC、BLE
	スクランブルキーパッド (PIN)	サポート対象
	QR/バーコード ³⁾	サポート対象 ⁴⁾
全般	CPU	1.5 GHz 4 コア
	メモリ	16 GB Flash + 1 GB RAM
	クリプトチップ	サポート対象
	LCD タイプ	4 インチ IPS カラー LCD
	LCD 解像度	480 x 800
	サウンド	24 ビット
	動作温度	-20 °C ~ 50 °C
	保管温度	-40 °C ~ 70 °C
	動作湿度	0 % ~ 80 %、結露しないこと
	保管湿度	0 % ~ 90 %、結露しないこと
	カメラのタイプ	CMOS 2M ピクセル
	カメラ解像度	1600 x 1200
	寸法 (W x H x D)	82 x 208.5 x 53 (下) / 25.9 (上) (mm)
	重量	<ul style="list-style-type: none"> • デバイス:375 g • ブラケット:86 g (ワッシャーとボルトを含む)
	IP 等級	IP65
	証明書	CE、UKCA、KC、FCC、IC、RCM、BIS、ANATEL、SIG、RoHS、REACH、WEEE
	指紋	画像寸法
解像度		500 dpi
テンプレート		SUPREMA / ISO19794-2、ANSI-378
エクストラクタ/マッチャー		MINEX 認定および準拠
センサー証明書		FBI PIV および FBI モバイル ID FAP20
偽造指紋検出		サポート対象 (SW ベース)
容量	最大ユーザー数	500,000 ⁵⁾
	最大クレデンシャル (1:N)	指紋:100,000
	最大クレデンシャル (1:1)	<ul style="list-style-type: none"> • 指紋:500,000 • カード:500,000 • PIN:500,000
	テキストログの最大数	5,000,000
	画像ログの最大数	50,000

カテゴリ	機能	仕様
インターフェイス	イーサネット	サポート対象 (10/100 Mbps、自動 MDI/MDI-X)
	RS-485	1 チャンネルホストまたはスレーブ (選択可能)
	RS-485 通信プロトコル	OSDP V2 準拠
	Wiegand	1 チャンネル入力または出力 (選択可能)
	TTL 入力	2 チャンネル入力
	リレー	リレー 1
	USB	USB 2.0 (ホスト)
	PoE	サポート対象 (IEEE 802.3af 互換)
	タンパー	サポート対象
電気関連	電源	<ul style="list-style-type: none"> 電圧: 12 Vdc 電流: 最大 0.8 A 電圧: 24 Vdc 電流: 最大 0.5 A
	スイッチ入力 VIH	<ul style="list-style-type: none"> 最小: 3 V 最大: 5 V
	スイッチ入力 VIL	最大: 1 V
	スイッチプルアップ抵抗	4.7 k Ω (入力ポートは 4.7 k Ω でプルアップする)
	Wiegand 出力 VOH	4.8 V 以上
	Wiegand 出力 VOL	0.2 V 未満
	Wiegand 出力プルアップ抵抗	1 k Ω の内部プルアップ
	リレー	2 A @ 30 VDC 抵抗負荷 1 A @ 30 VDC 誘導負荷

- 1) DESFire EV2/EV3 カードは、DESFire EV1 カードとの下位互換性によりサポートされています。CSN およびスマートカード機能は、X-Station 2 と互換性があります。
- 2) RF 読み取り範囲は、設置環境によって異なります。
- 3) 最大 32 個の ASCII コードの列で構成される QR/バーコードをサポートします。
- 4) 別途ライセンスが必要です。
- 5) 認証情報データなしで登録されたユーザーの数です。

寸法

(単位: mm)

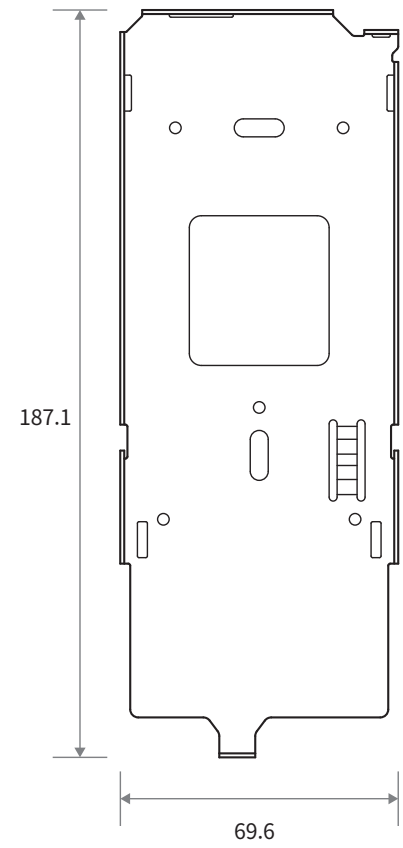
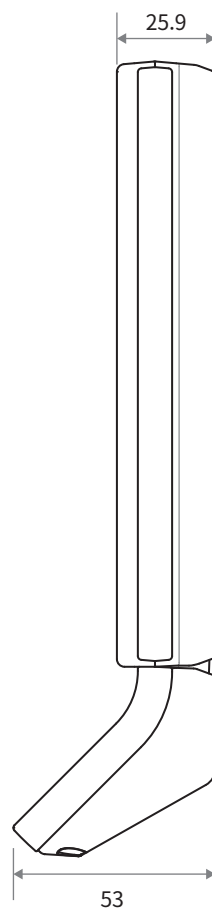
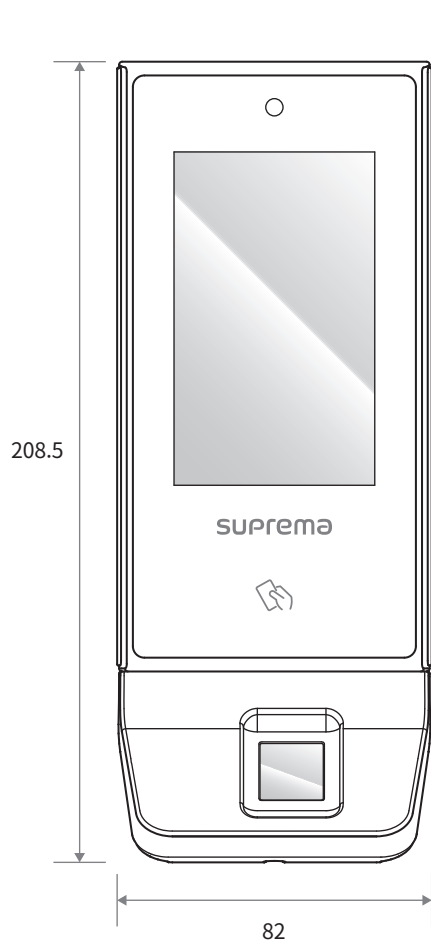

FCC 準拠情報

このデバイスは、FCC 規則第 15 部に準拠しています。

動作は、次の 2 つの条件に従います。

- (1) このデバイスは、有害な電波干渉を引き起こしてはなりません。また、
- (2) このデバイスは、望ましくない動作を引き起こす可能性のある電波干渉を含め、受信したあらゆる電波干渉を許容する必要があります。



この装置は、FCC 規則の第 15 部に従って、クラス A デジタルデバイスの制限に準拠していることがテストおよび確認されています。これらの制限は、居住地域での設置において有害な電波干渉から適切に保護するためのものです。この装置は、無線周波エネルギーを生成、使用、および放射する可能性があり、指示に従って設置および使用しないと、無線通信に有害な電波干渉が発生することがあります。ただし、特定の設置で電波干渉が発生しないことを保証するものではありません。この装置のオフとオンを切り替えてみて、この装置によってラジオやテレビなどの受信に有害な電波干渉が発生することが判明した場合は、次の方法で電波干渉を解消してみてください。

- 受信アンテナの方向や場所を変更する。
- 装置と受信機の位置を離す。
- 受信機が接続されている回路とは別の回路のコンセントに機器を接続する。
- 販売店や、ラジオまたはテレビの経験豊富な技術者に相談する。

製造元によって明示的に承認されていない変更を行った場合、FCC 規則に基づき、ユーザーの装置を操作する権限が無効になる場合があります。

- この機器とそのアンテナを、他のアンテナや送信機と一緒に設置または操作しないでください。
- RF 被曝の要件を満たすため、アンテナとこの機器の使用者の間隔を 20 cm 以上空ける必要があります。

EU 適合宣言 (CE)

本製品は、RED (Radio Equipment Directive) 2014/53/EU の規定に従って CE マークが添付されています。Suprema Inc. はこれによって、本製品が RED (Radio Equipment Directive) 2014/53/EU の必須要件およびその他の関連規定に準拠していることを宣言します。

- Bluetooth 出力: -0.1 dBm
- Bluetooth 周波数: 2402~2480 MHz
- NFC 周波数: 13.56 MHz
- RFID 周波数: 13.56 MHz + 125 kHz

詳細については、次の連絡先にお問い合わせください。

Suprema Inc.

ウェブサイト: <https://www.supremainc.com>

住所: 17F Parkview Tower, 248, Jeongjail-ro, Bundang-gu, Seongnam-si, Gyeonggi-do, 13554, Rep. of KOREA

電話: +82-31-783-4502 / Fax: +82-31-783-4503

付録

免責事項

- 本書は、Suprema 製品に関する情報について記載したものです。
- 利用規約、販売条件に含まれるSuprema製品として保証されたもののみ使用権が認められます。明示的、黙示的に関わらず禁反言またはその他の方法により、いかなる知的財産権も本書によって付与されるものではありません。
- Suprema は、明示的および黙示的に関わらずすべての保証を否認します。これには特定目的への適合性、商品性、または非侵害性について黙示の保証を含むがこれに限定されません。お客様とSuprema間で契約書に明示的に記載されている場合はこの限りではありません。
- 以下のいずれかの状態に該当する Suprema 製品については、すべての保証が無効となります。1) 不適切に取り付けられている、またはハードウェアのシリアル番号、保証日、品質保証ステッカーが変更もしくは除去されている。2) Suprema が許可した方法以外で使用されている。3) Suprema 認定業者以外の者または第三者によって修正、変更、修理されている。4) 不適切な環境条件における運用または保守が行われている。
- Suprema 製品は、医療、救命、生命維持装置などといった、故障した場合に人身傷害や死亡事故が発生する可能性のある用途での使用を目的としたものではありません。お客様が意図しない、または許可されていない用途のために Suprema 製品を購入、使用した場合、意図しない、または許可されていない用途に関連する人身傷害や死亡事故に関する直接的または間接的に起因するすべての請求、費用、損害、および経費ならびに合理的な弁護士費用については、当該製品の設計または製造に関して Suprema に過失があったと主張する場合であっても、Suprema およびその役員、従業員、子会社、関連会社、販売代理店を免責するものとします。
- Suprema は、信頼性、機能、設計を向上させるために、予告なく仕様および製品の詳細を変更する場合があります。あらかじめご了承ください。
- Suprema 製品の使用中に、認証メッセージおよびその他の関連情報の形式で、個人情報当該製品内に保存される場合があります。Suprema 製品内に保存されている個人情報を含むいかなる情報についても、当該製品が Suprema の直接の管理下でない場合、または関連する規約に当該製品の記載がない場合には、一切の責任を負いません。個人情報を含む保存された情報を使用する場合、製品使用者の責任において、国内の法令 (GDPR など) を遵守し、適切な取り扱いおよび処理を行うようにするものとします。
- 「実装予定」については、実装予定という状態に依拠してはなりません。Suprema は、これらについて留保しており、今後の変更に起因する仕様の変更、非互換性については、一切の責任を負いません。
- 本書で明示的に定められている場合を除き、法律で許可されている最大範囲において、Suprema 製品は「現状のまま」販売されます。
- 注文前に仕様について確認の必要がある場合は、最寄りの Suprema 営業所・販売代理店にお問い合わせください。

著作権表示

本文書の著作権は Suprema に帰属します。その他の製品名、商標、登録商標の権利は、これらの権利を所有している各個人または組織に帰属します。

オープンソースライセンス

- 本製品のソフトウェアは、GPL の下で使用許諾されている「Linux Kernel 4.x」に基づいています。GPL については、本マニュアルの「[GNU General Public License](#)」を参照してください。
- 本製品では、OpenSSL およびオリジナル SSLeay のライセンスの下で使用許諾されている「BoringSSL」を使用します。OpenSSL およびオリジナル SSLeay のライセンスについては、本マニュアルの「[BoringSSL License](#)」を参照してください。
- 本製品では、オリジナル SSLeay ライセンスの下で使用許諾されている「オリジナルの SSLeay」を使用します。オリジナル SSLeay ライセンスについては、本マニュアルの「[Original SSLeay License](#)」を参照してください。
- 本製品では、Apache License 2.0 の下で使用許諾されている「AOSP」を使用します。Apache License 2.0 については、本マニュアルの「[Apache License](#)」を参照してください。
- 本製品に含まれる、Linux Kernel 4.x に基づいた修正済みソースコードと、BoringSSL、オリジナルの SSLeay、AOSP のソースコードが必要な場合は、support.supremainc.comからお問い合わせください。

GNU General Public License

Version 3, 29 June 2007

Copyright © 2007 Free Software Foundation, Inc. <<http://fsf.org/>>

Everyone is permitted to copy and distribute verbatim copies of this license document, but changing it is not allowed.

Preamble

The GNU General Public License is a free, copyleft license for software and other kinds of works.

The licenses for most software and other practical works are designed to take away your freedom to share and change the works. By contrast, the GNU General Public License is intended to guarantee your freedom to share and change all versions of a program--to make sure it remains free software for all its users. We, the Free Software Foundation, use the GNU General Public License for most of our software; it applies also to any other work released this way by its authors. You can apply it to your programs, too.

When we speak of free software, we are referring to freedom, not price. Our General Public Licenses are designed to make sure that you have the freedom to distribute copies of free software (and charge for them if you wish), that you receive source code or can get it if you want it, that you can change the software or use pieces of it in new free programs, and that you know you can do these things.

To protect your rights, we need to prevent others from denying you these rights or asking you to surrender the rights. Therefore, you have certain responsibilities if you distribute copies of the software, or if you modify it: responsibilities to respect the freedom of others.

For example, if you distribute copies of such a program, whether gratis or for a fee, you must pass on to the recipients the same freedoms that you received. You must make sure that they, too, receive or can get the source code. And you must show them these terms so they know their rights.

Developers that use the GNU GPL protect your rights with two steps: (1) assert copyright on the software, and (2) offer you this License giving you legal permission to copy, distribute and/or modify it.

For the developers' and authors' protection, the GPL clearly explains that there is no warranty for this free software. For both users' and authors' sake, the GPL requires that modified versions be marked as changed, so that their problems will not be attributed erroneously to authors of previous versions.

Some devices are designed to deny users access to install or run modified versions of the software inside them, although the manufacturer can do so. This is fundamentally incompatible with the aim of protecting users' freedom to change the software. The systematic pattern of such abuse occurs in the area of products for individuals to use, which is precisely where it is most unacceptable. Therefore, we have designed this version of the GPL to prohibit the practice for those products. If such problems arise substantially in other domains, we stand ready to extend this provision to those domains in future versions of the GPL, as needed to protect the freedom of users.

Finally, every program is threatened constantly by software patents. States should not allow patents to restrict development and use of software on general-purpose computers, but in those that do, we wish to avoid the special danger that patents applied to a free program could make it effectively proprietary. To prevent this, the GPL assures that patents cannot be used to render the program non-free.

The precise terms and conditions for copying, distribution and modification follow.

TERMS AND CONDITIONS

0. Definitions.

“This License” refers to version 3 of the GNU General Public License.

“Copyright” also means copyright-like laws that apply to other kinds of works, such as semiconductor masks.

“The Program” refers to any copyrightable work licensed under this License. Each licensee is addressed as “you”.

“Licensees” and “recipients” may be individuals or organizations.

To “modify” a work means to copy from or adapt all or part of the work in a fashion requiring copyright permission, other than the making of an exact copy. The resulting work is called a “modified version” of the earlier work or a work “based on” the earlier work.

A “covered work” means either the unmodified Program or a work based on the Program.

To “propagate” a work means to do anything with it that, without permission, would make you directly or secondarily liable for infringement under applicable copyright law, except executing it on a computer or modifying a private copy. Propagation includes copying, distribution (with or without modification), making available to the public, and in some countries other activities as well.

To “convey” a work means any kind of propagation that enables other parties to make or receive copies. Mere interaction with a user through a computer network, with no transfer of a copy, is not conveying.

An interactive user interface displays “Appropriate Legal Notices” to the extent that it includes a convenient and prominently visible feature that (1) displays an appropriate copyright notice, and (2) tells the user that there is no warranty for the work (except to the extent that warranties are provided), that licensees may convey the work under this License, and how to view a copy of this License. If the interface presents a list of user commands or options, such as a menu, a prominent item in the list meets this criterion.

1. Source Code.

The “source code” for a work means the preferred form of the work for making modifications to it. “Object code” means any non-source form of a work.

A “Standard Interface” means an interface that either is an official standard defined by a recognized standards body, or, in the case of interfaces specified for a particular programming language, one that is widely used among developers working in that language.

The “System Libraries” of an executable work include anything, other than the work as a whole, that (a) is included in the normal form of packaging a Major Component, but which is not part of that Major Component, and (b) serves only to enable use of the work with that Major Component, or to implement a Standard Interface for which an implementation is available to the public in source code form. A “Major Component”, in this context, means a major essential component (kernel, window system, and so on) of the specific operating system (if any) on which the executable work runs, or a compiler used to produce the work, or an object code interpreter used to run it.

The “Corresponding Source” for a work in object code form means all the source code needed to generate, install, and (for an executable work) run the object code and to modify the work, including scripts to control those activities. However, it does not include the work’s System Libraries, or general-purpose tools or generally available free programs which are used unmodified in performing those activities but which are not part of the work. For example, Corresponding Source includes interface definition files associated with source files for the work, and the source code for shared libraries and dynamically linked subprograms that the work is specifically designed to require, such as by intimate data communication or control flow between those subprograms and other parts of the work.

The Corresponding Source need not include anything that users can regenerate automatically from other parts of the Corresponding Source.

The Corresponding Source for a work in source code form is that same work.

2. Basic Permissions.

All rights granted under this License are granted for the term of copyright on the Program, and are irrevocable provided the stated conditions are met. This License explicitly affirms your unlimited permission to run the unmodified Program. The output from running a covered work is covered by this License only if the output, given its content, constitutes a covered work. This License acknowledges your rights of fair use or other equivalent, as provided by copyright law.

You may make, run and propagate covered works that you do not convey, without conditions so long as your license otherwise remains in force. You may convey covered works to others for the sole purpose of having them make modifications exclusively for you, or provide you with facilities for running those works, provided that you comply with the terms of this License in conveying all material for which you do not control copyright. Those thus making or running the covered works for you must do so exclusively on your behalf, under your direction and control, on terms that prohibit them from making any copies of your copyrighted material outside their relationship with you.

Conveying under any other circumstances is permitted solely under the conditions stated below. Sublicensing is not allowed; section 10 makes it unnecessary.

3. Protecting Users' Legal Rights From Anti-Circumvention Law.

No covered work shall be deemed part of an effective technological measure under any applicable law fulfilling obligations under article 11 of the WIPO copyright treaty adopted on 20 December 1996, or similar laws prohibiting or restricting circumvention of such measures.

When you convey a covered work, you waive any legal power to forbid circumvention of technological measures to the extent such circumvention is effected by exercising rights under this License with respect to the covered work, and you disclaim any intention to limit operation or modification of the work as a means of enforcing, against the work's users, your or third parties' legal rights to forbid circumvention of technological measures.

4. Conveying Verbatim Copies.

You may convey verbatim copies of the Program's source code as you receive it, in any medium, provided that you conspicuously and appropriately publish on each copy an appropriate copyright notice; keep intact all notices stating that this License and any non-permissive terms added in accord with section 7 apply to the code; keep intact all notices of the absence of any warranty; and give all recipients a copy of this License along with the Program.

You may charge any price or no price for each copy that you convey, and you may offer support or warranty protection for a fee.

5. Conveying Modified Source Versions.

You may convey a work based on the Program, or the modifications to produce it from the Program, in the form of source code under the terms of section 4, provided that you also meet all of these conditions:

- a) The work must carry prominent notices stating that you modified it, and giving a relevant date.
- b) The work must carry prominent notices stating that it is released under this License and any conditions added under section 7. This requirement modifies the requirement in section 4 to "keep intact all notices".
- c) You must license the entire work, as a whole, under this License to anyone who comes into possession of a copy. This License will therefore apply, along with any applicable section 7 additional terms, to the whole of the work, and all its parts, regardless of how they are packaged. This License gives no permission to license the work in any other way, but it does not invalidate such permission if you have separately received it.
- d) If the work has interactive user interfaces, each must display Appropriate Legal Notices; however, if the Program has interactive interfaces that do not display Appropriate Legal Notices, your work need not make them do so.

A compilation of a covered work with other separate and independent works, which are not by their nature extensions of the covered work, and which are not combined with it such as to form a larger program, in or on a volume of a storage or distribution medium, is called an "aggregate" if the compilation and its resulting copyright are not used to limit the access or legal rights of the compilation's users beyond what the individual works permit. Inclusion of a covered work in an aggregate does not cause this License to apply to the other parts of the aggregate.

6. Conveying Non-Source Forms.

You may convey a covered work in object code form under the terms of sections 4 and 5, provided that you also convey the machine-readable Corresponding Source under the terms of this License, in one of these ways:

- a) Convey the object code in, or embodied in, a physical product (including a physical distribution medium), accompanied by the Corresponding Source fixed on a durable physical medium customarily used for software interchange.
- b) Convey the object code in, or embodied in, a physical product (including a physical distribution medium), accompanied by a written offer, valid for at least three years and valid for as long as you offer spare parts or customer support for that product model, to give anyone who possesses the object code either (1) a copy of the Corresponding Source for all the software in the product that is covered by this License, on a durable physical medium customarily used for software interchange, for a price no more than your reasonable cost of physically performing this conveying of source, or (2) access to copy the Corresponding Source from a network server at no charge.
- c) Convey individual copies of the object code with a copy of the written offer to provide the Corresponding Source. This alternative is allowed only occasionally and noncommercially, and only if you received the object code with such an offer, in accord with subsection 6b.

- d) Convey the object code by offering access from a designated place (gratis or for a charge), and offer equivalent access to the Corresponding Source in the same way through the same place at no further charge. You need not require recipients to copy the Corresponding Source along with the object code. If the place to copy the object code is a network server, the Corresponding Source may be on a different server (operated by you or a third party) that supports equivalent copying facilities, provided you maintain clear directions next to the object code saying where to find the Corresponding Source. Regardless of what server hosts the Corresponding Source, you remain obligated to ensure that it is available for as long as needed to satisfy these requirements.
- e) Convey the object code using peer-to-peer transmission, provided you inform other peers where the object code and Corresponding Source of the work are being offered to the general public at no charge under subsection 6d.

A separable portion of the object code, whose source code is excluded from the Corresponding Source as a System Library, need not be included in conveying the object code work.

A “User Product” is either (1) a “consumer product”, which means any tangible personal property which is normally used for personal, family, or household purposes, or (2) anything designed or sold for incorporation into a dwelling. In determining whether a product is a consumer product, doubtful cases shall be resolved in favor of coverage. For a particular product received by a particular user, “normally used” refers to a typical or common use of that class of product, regardless of the status of the particular user or of the way in which the particular user actually uses, or expects or is expected to use, the product. A product is a consumer product regardless of whether the product has substantial commercial, industrial or non-consumer uses, unless such uses represent the only significant mode of use of the product.

“Installation Information” for a User Product means any methods, procedures, authorization keys, or other information required to install and execute modified versions of a covered work in that User Product from a modified version of its Corresponding Source. The information must suffice to ensure that the continued functioning of the modified object code is in no case prevented or interfered with solely because modification has been made.

If you convey an object code work under this section in, or with, or specifically for use in, a User Product, and the conveying occurs as part of a transaction in which the right of possession and use of the User Product is transferred to the recipient in perpetuity or for a fixed term (regardless of how the transaction is characterized), the Corresponding Source conveyed under this section must be accompanied by the Installation Information. But this requirement does not apply if neither you nor any third party retains the ability to install modified object code on the User Product (for example, the work has been installed in ROM).

The requirement to provide Installation Information does not include a requirement to continue to provide support service, warranty, or updates for a work that has been modified or installed by the recipient, or for the User Product in which it has been modified or installed. Access to a network may be denied when the modification itself materially and adversely affects the operation of the network or violates the rules and protocols for communication across the network.

Corresponding Source conveyed, and Installation Information provided, in accord with this section must be in a format that is publicly documented (and with an implementation available to the public in source code form), and must require no special password or key for unpacking, reading or copying.

7. Additional Terms.

“Additional permissions” are terms that supplement the terms of this License by making exceptions from one or more of its conditions. Additional permissions that are applicable to the entire Program shall be treated as though they were included in this License, to the extent that they are valid under applicable law. If additional permissions apply only to part of the Program, that part may be used separately under those permissions, but the entire Program remains governed by this License without regard to the additional permissions.

When you convey a copy of a covered work, you may at your option remove any additional permissions from that copy, or from any part of it. (Additional permissions may be written to require their own removal in certain cases when you modify the work.) You may place additional permissions on material, added by you to a covered work, for which you have or can give appropriate copyright permission.

Notwithstanding any other provision of this License, for material you add to a covered work, you may (if authorized by the copyright holders of that material) supplement the terms of this License with terms:

- a) Disclaiming warranty or limiting liability differently from the terms of sections 15 and 16 of this License; or
- b) Requiring preservation of specified reasonable legal notices or author attributions in that material or in the Appropriate Legal Notices displayed by works containing it; or
- c) Prohibiting misrepresentation of the origin of that material, or requiring that modified versions of such material be marked in reasonable ways as different from the original version; or

- d) Limiting the use for publicity purposes of names of licensors or authors of the material; or
- e) Declining to grant rights under trademark law for use of some trade names, trademarks, or service marks; or
- f) Requiring indemnification of licensors and authors of that material by anyone who conveys the material (or modified versions of it) with contractual assumptions of liability to the recipient, for any liability that these contractual assumptions directly impose on those licensors and authors.

All other non-permissive additional terms are considered “further restrictions” within the meaning of section 10. If the Program as you received it, or any part of it, contains a notice stating that it is governed by this License along with a term that is a further restriction, you may remove that term. If a license document contains a further restriction but permits relicensing or conveying under this License, you may add to a covered work material governed by the terms of that license document, provided that the further restriction does not survive such relicensing or conveying.

If you add terms to a covered work in accord with this section, you must place, in the relevant source files, a statement of the additional terms that apply to those files, or a notice indicating where to find the applicable terms.

Additional terms, permissive or non-permissive, may be stated in the form of a separately written license, or stated as exceptions; the above requirements apply either way.

8. Termination.

You may not propagate or modify a covered work except as expressly provided under this License. Any attempt otherwise to propagate or modify it is void, and will automatically terminate your rights under this License (including any patent licenses granted under the third paragraph of section 11).

However, if you cease all violation of this License, then your license from a particular copyright holder is reinstated (a) provisionally, unless and until the copyright holder explicitly and finally terminates your license, and (b) permanently, if the copyright holder fails to notify you of the violation by some reasonable means prior to 60 days after the cessation.

Moreover, your license from a particular copyright holder is reinstated permanently if the copyright holder notifies you of the violation by some reasonable means, this is the first time you have received notice of violation of this License (for any work) from that copyright holder, and you cure the violation prior to 30 days after your receipt of the notice.

Termination of your rights under this section does not terminate the licenses of parties who have received copies or rights from you under this License. If your rights have been terminated and not permanently reinstated, you do not qualify to receive new licenses for the same material under section 10.

9. Acceptance Not Required for Having Copies.

You are not required to accept this License in order to receive or run a copy of the Program. Ancillary propagation of a covered work occurring solely as a consequence of using peer-to-peer transmission to receive a copy likewise does not require acceptance. However, nothing other than this License grants you permission to propagate or modify any covered work. These actions infringe copyright if you do not accept this License. Therefore, by modifying or propagating a covered work, you indicate your acceptance of this License to do so.

10. Automatic Licensing of Downstream Recipients.

Each time you convey a covered work, the recipient automatically receives a license from the original licensors, to run, modify and propagate that work, subject to this License. You are not responsible for enforcing compliance by third parties with this License.

An “entity transaction” is a transaction transferring control of an organization, or substantially all assets of one, or subdividing an organization, or merging organizations. If propagation of a covered work results from an entity transaction, each party to that transaction who receives a copy of the work also receives whatever licenses to the work the party’s predecessor in interest had or could give under the previous paragraph, plus a right to possession of the Corresponding Source of the work from the predecessor in interest, if the predecessor has it or can get it with reasonable efforts.

You may not impose any further restrictions on the exercise of the rights granted or affirmed under this License. For example, you may not impose a license fee, royalty, or other charge for exercise of rights granted under this License, and you may not initiate litigation (including a cross-claim or counterclaim in a lawsuit) alleging that any patent claim is infringed by making, using, selling, offering for sale, or importing the Program or any portion of it.

11. Patents.

A “contributor” is a copyright holder who authorizes use under this License of the Program or a work on which the Program is based. The work thus licensed is called the contributor's “contributor version”.

A contributor's “essential patent claims” are all patent claims owned or controlled by the contributor, whether already acquired or hereafter acquired, that would be infringed by some manner, permitted by this License, of making, using, or selling its contributor version, but do not include claims that would be infringed only as a consequence of further modification of the contributor version. For purposes of this definition, “control” includes the right to grant patent sublicenses in a manner consistent with the requirements of this License.

Each contributor grants you a non-exclusive, worldwide, royalty-free patent license under the contributor's essential patent claims, to make, use, sell, offer for sale, import and otherwise run, modify and propagate the contents of its contributor version.

In the following three paragraphs, a “patent license” is any express agreement or commitment, however denominated, not to enforce a patent (such as an express permission to practice a patent or covenant not to sue for patent infringement). To “grant” such a patent license to a party means to make such an agreement or commitment not to enforce a patent against the party.

If you convey a covered work, knowingly relying on a patent license, and the Corresponding Source of the work is not available for anyone to copy, free of charge and under the terms of this License, through a publicly available network server or other readily accessible means, then you must either (1) cause the Corresponding Source to be so available, or (2) arrange to deprive yourself of the benefit of the patent license for this particular work, or (3) arrange, in a manner consistent with the requirements of this License, to extend the patent license to downstream recipients. “Knowingly relying” means you have actual knowledge that, but for the patent license, your conveying the covered work in a country, or your recipient's use of the covered work in a country, would infringe one or more identifiable patents in that country that you have reason to believe are valid.

If, pursuant to or in connection with a single transaction or arrangement, you convey, or propagate by procuring conveyance of, a covered work, and grant a patent license to some of the parties receiving the covered work authorizing them to use, propagate, modify or convey a specific copy of the covered work, then the patent license you grant is automatically extended to all recipients of the covered work and works based on it.

A patent license is “discriminatory” if it does not include within the scope of its coverage, prohibits the exercise of, or is conditioned on the non-exercise of one or more of the rights that are specifically granted under this License. You may not convey a covered work if you are a party to an arrangement with a third party that is in the business of distributing software, under which you make payment to the third party based on the extent of your activity of conveying the work, and under which the third party grants, to any of the parties who would receive the covered work from you, a discriminatory patent license (a) in connection with copies of the covered work conveyed by you (or copies made from those copies), or (b) primarily for and in connection with specific products or compilations that contain the covered work, unless you entered into that arrangement, or that patent license was granted, prior to 28 March 2007.

Nothing in this License shall be construed as excluding or limiting any implied license or other defenses to infringement that may otherwise be available to you under applicable patent law.

12. No Surrender of Others' Freedom.

If conditions are imposed on you (whether by court order, agreement or otherwise) that contradict the conditions of this License, they do not excuse you from the conditions of this License. If you cannot convey a covered work so as to satisfy simultaneously your obligations under this License and any other pertinent obligations, then as a consequence you may not convey it at all. For example, if you agree to terms that obligate you to collect a royalty for further conveying from those to whom you convey the Program, the only way you could satisfy both those terms and this License would be to refrain entirely from conveying the Program.

13. Use with the GNU Affero General Public License.

Notwithstanding any other provision of this License, you have permission to link or combine any covered work with a work licensed under version 3 of the GNU Affero General Public License into a single combined work, and to convey the resulting work. The terms of this License will continue to apply to the part which is the covered work, but the special requirements of the GNU Affero General Public License, section 13, concerning interaction through a network will apply to the combination as such.

14. Revised Versions of this License.

The Free Software Foundation may publish revised and/or new versions of the GNU General Public License from time to time. Such new versions will be similar in spirit to the present version, but may differ in detail to address new problems or concerns.

Each version is given a distinguishing version number. If the Program specifies that a certain numbered version of the GNU General Public License “or any later version” applies to it, you have the option of following the terms and conditions either of that numbered version or of any later version published by the Free Software Foundation. If the Program does not specify a version number of the GNU General Public License, you may choose any version ever published by the Free Software Foundation.

If the Program specifies that a proxy can decide which future versions of the GNU General Public License can be used, that proxy's public statement of acceptance of a version permanently authorizes you to choose that version for the Program.

Later license versions may give you additional or different permissions. However, no additional obligations are imposed on any author or copyright holder as a result of your choosing to follow a later version.

15. Disclaimer of Warranty.

THERE IS NO WARRANTY FOR THE PROGRAM, TO THE EXTENT PERMITTED BY APPLICABLE LAW. EXCEPT WHEN OTHERWISE STATED IN WRITING THE COPYRIGHT HOLDERS AND/OR OTHER PARTIES PROVIDE THE PROGRAM “AS IS” WITHOUT WARRANTY OF ANY KIND, EITHER EXPRESSED OR IMPLIED, INCLUDING, BUT NOT LIMITED TO, THE IMPLIED WARRANTIES OF MERCHANTABILITY AND FITNESS FOR A PARTICULAR PURPOSE. THE ENTIRE RISK AS TO THE QUALITY AND PERFORMANCE OF THE PROGRAM IS WITH YOU. SHOULD THE PROGRAM PROVE DEFECTIVE, YOU ASSUME THE COST OF ALL NECESSARY SERVICING, REPAIR OR CORRECTION.

16. Limitation of Liability.

IN NO EVENT UNLESS REQUIRED BY APPLICABLE LAW OR AGREED TO IN WRITING WILL ANY COPYRIGHT HOLDER, OR ANY OTHER PARTY WHO MODIFIES AND/OR CONVEYS THE PROGRAM AS PERMITTED ABOVE, BE LIABLE TO YOU FOR DAMAGES, INCLUDING ANY GENERAL, SPECIAL, INCIDENTAL OR CONSEQUENTIAL DAMAGES ARISING OUT OF THE USE OR INABILITY TO USE THE PROGRAM (INCLUDING BUT NOT LIMITED TO LOSS OF DATA OR DATA BEING RENDERED INACCURATE OR LOSSES SUSTAINED BY YOU OR THIRD PARTIES OR A FAILURE OF THE PROGRAM TO OPERATE WITH ANY OTHER PROGRAMS), EVEN IF SUCH HOLDER OR OTHER PARTY HAS BEEN ADVISED OF THE POSSIBILITY OF SUCH DAMAGES.

17. Interpretation of Sections 15 and 16.

If the disclaimer of warranty and limitation of liability provided above cannot be given local legal effect according to their terms, reviewing courts shall apply local law that most closely approximates an absolute waiver of all civil liability in connection with the Program, unless a warranty or assumption of liability accompanies a copy of the Program in return for a fee.

END OF TERMS AND CONDITIONS

BoringSSL License

BoringSSL is a fork of OpenSSL. As such, large parts of it fall under OpenSSL licensing. Files that are completely new have a Google copyright and an ISC license. This license is reproduced at the bottom of this file.

Contributors to BoringSSL are required to follow the CLA rules for Chromium: <https://cla.developers.google.com/cla>

Files in `third_party/` have their own licenses, as described therein. The MIT license, for `third_party/fiat`, which, unlike other `third_party` directories, is compiled into non-test libraries, is included below.

The OpenSSL toolkit stays under a dual license, i.e. both the conditions of the OpenSSL License and the original SSLeay license apply to the toolkit. See below for the actual license texts. Actually both licenses are BSD-style Open Source licenses. In case of any license issues related to OpenSSL please contact openssl-core@openssl.org.

The following are Google-internal bug numbers where explicit permission from some authors is recorded for use of their work. (This is purely for our own record keeping.)

27287199

27287880

27287883

OpenSSL License

Copyright (c) 1998-2011 The OpenSSL Project. All rights reserved.

Redistribution and use in source and binary forms, with or without modification, are permitted provided that the following conditions are met:

1. Redistributions of source code must retain the above copyright notice, this list of conditions and the following disclaimer.
2. Redistributions in binary form must reproduce the above copyright notice, this list of conditions and the following disclaimer in the documentation and/or other materials provided with the distribution.
3. All advertising materials mentioning features or use of this software must display the following acknowledgment: "This product includes software developed by the OpenSSL Project for use in the OpenSSL Toolkit. (<http://www.openssl.org/>)"
4. The names "OpenSSL Toolkit" and "OpenSSL Project" must not be used to endorse or promote products derived from this software without prior written permission. For written permission, please contact openssl-core@openssl.org.
5. Products derived from this software may not be called "OpenSSL" nor may "OpenSSL" appear in their names without prior written permission of the OpenSSL Project.
6. Redistributions of any form whatsoever must retain the following acknowledgment: "This product includes software developed by the OpenSSL Project for use in the OpenSSL Toolkit (<http://www.openssl.org/>)"

THIS SOFTWARE IS PROVIDED BY THE OpenSSL PROJECT ``AS IS'' AND ANY EXPRESSED OR IMPLIED WARRANTIES, INCLUDING, BUT NOT LIMITED TO, THE IMPLIED WARRANTIES OF MERCHANTABILITY AND FITNESS FOR A PARTICULAR PURPOSE ARE DISCLAIMED. IN NO EVENT SHALL THE OpenSSL PROJECT OR ITS CONTRIBUTORS BE LIABLE FOR ANY DIRECT, INDIRECT, INCIDENTAL, SPECIAL, EXEMPLARY, OR CONSEQUENTIAL DAMAGES (INCLUDING, BUT NOT LIMITED TO, PROCUREMENT OF SUBSTITUTE GOODS OR SERVICES; LOSS OF USE, DATA, OR PROFITS; OR BUSINESS INTERRUPTION) HOWEVER CAUSED AND ON ANY THEORY OF LIABILITY, WHETHER IN CONTRACT, STRICT LIABILITY, OR TORT (INCLUDING NEGLIGENCE OR OTHERWISE) ARISING IN ANY WAY OUT OF THE USE OF THIS SOFTWARE, EVEN IF ADVISED OF THE POSSIBILITY OF SUCH DAMAGE.

This product includes cryptographic software written by Eric Young (ey@cryptsoft.com). This product includes software written by Tim Hudson (tjh@cryptsoft.com).

Original SSLeay License

Copyright (C) 1995-1998 Eric Young (eay@cryptsoft.com) All rights reserved.

This package is an SSL implementation written by Eric Young (eay@cryptsoft.com). The implementation was written so as to conform with Netscapes SSL.

This library is free for commercial and non-commercial use as long as the following conditions are adhered to. The following conditions apply to all code found in this distribution, be it the RC4, RSA, lhash, DES, etc., code; not just the SSL code. The SSL documentation included with this distribution is covered by the same copyright terms except that the holder is Tim Hudson (tjh@cryptsoft.com).

Copyright remains Eric Young's, and as such any Copyright notices in the code are not to be removed. If this package is used in a product, Eric Young should be given attribution as the author of the parts of the library used. This can be in the form of a textual message at program startup or in documentation (online or textual) provided with the package.

Redistribution and use in source and binary forms, with or without modification, are permitted provided that the following conditions are met:

1. Redistributions of source code must retain the copyright notice, this list of conditions and the following disclaimer.
2. Redistributions in binary form must reproduce the above copyright notice, this list of conditions and the following disclaimer in the documentation and/or other materials provided with the distribution.
3. All advertising materials mentioning features or use of this software must display the following acknowledgement: "This product includes cryptographic software written by Eric Young (eay@cryptsoft.com)" The word 'cryptographic' can be left out if the routines from the library being used are not cryptographic related :-).
4. If you include any Windows specific code (or a derivative thereof) from the apps directory (application code) you must include an acknowledgement: "This product includes software written by Tim Hudson (tjh@cryptsoft.com)"

THIS SOFTWARE IS PROVIDED BY ERIC YOUNG ``AS IS'' AND ANY EXPRESS OR IMPLIED WARRANTIES, INCLUDING, BUT NOT LIMITED TO, THE IMPLIED WARRANTIES OF MERCHANTABILITY AND FITNESS FOR A PARTICULAR PURPOSE ARE DISCLAIMED. IN NO EVENT SHALL THE AUTHOR OR CONTRIBUTORS BE LIABLE FOR ANY DIRECT, INDIRECT, INCIDENTAL, SPECIAL, EXEMPLARY, OR CONSEQUENTIAL DAMAGES (INCLUDING, BUT NOT LIMITED TO, PROCUREMENT OF SUBSTITUTE GOODS OR SERVICES; LOSS OF USE, DATA, OR PROFITS; OR BUSINESS INTERRUPTION) HOWEVER CAUSED AND ON ANY THEORY OF LIABILITY, WHETHER IN CONTRACT, STRICT LIABILITY, OR TORT (INCLUDING NEGLIGENCE OR OTHERWISE) ARISING IN ANY WAY OUT OF THE USE OF THIS SOFTWARE, EVEN IF ADVISED OF THE POSSIBILITY OF SUCH DAMAGE.

The licence and distribution terms for any publically available version or derivative of this code cannot be changed. i.e. this code cannot simply be copied and put under another distribution licence [including the GNU Public Licence.]

ISC license used for completely new code in BoringSSL:

Copyright (c) 2015, Google Inc.

Permission to use, copy, modify, and/or distribute this software for any purpose with or without fee is hereby granted, provided that the above copyright notice and this permission notice appear in all copies.

THE SOFTWARE IS PROVIDED "AS IS" AND THE AUTHOR DISCLAIMS ALL WARRANTIES WITH REGARD TO THIS SOFTWARE INCLUDING ALL IMPLIED WARRANTIES OF MERCHANTABILITY AND FITNESS. IN NO EVENT SHALL THE AUTHOR BE LIABLE FOR ANY SPECIAL, DIRECT, INDIRECT, OR CONSEQUENTIAL DAMAGES OR ANY DAMAGES WHATSOEVER RESULTING FROM LOSS OF USE, DATA OR PROFITS, WHETHER IN AN ACTION OF CONTRACT, NEGLIGENCE OR OTHER TORTIOUS ACTION, ARISING OUT OF OR IN CONNECTION WITH THE USE OR PERFORMANCE OF THIS SOFTWARE.

The code in `third_party/ fiat` carries the MIT license:

Copyright (c) 2015-2016 the fiat-crypto authors (see <https://github.com/mit-plv/fiat-crypto/blob/master/AUTHORS>).

Permission is hereby granted, free of charge, to any person obtaining a copy of this software and associated documentation files (the "Software"), to deal in the Software without restriction, including without limitation the rights to use, copy, modify, merge, publish, distribute, sublicense, and/or sell copies of the Software, and to permit persons to whom the Software is furnished to do so, subject to the following conditions:

The above copyright notice and this permission notice shall be included in all copies or substantial portions of the Software.

THE SOFTWARE IS PROVIDED "AS IS", WITHOUT WARRANTY OF ANY KIND, EXPRESS OR IMPLIED, INCLUDING BUT NOT LIMITED TO THE WARRANTIES OF MERCHANTABILITY, FITNESS FOR A PARTICULAR PURPOSE AND NONINFRINGEMENT. IN NO EVENT SHALL THE AUTHORS OR COPYRIGHT HOLDERS BE LIABLE FOR ANY CLAIM, DAMAGES OR OTHER LIABILITY, WHETHER IN AN ACTION OF CONTRACT, TORT OR OTHERWISE, ARISING FROM, OUT OF OR IN CONNECTION WITH THE SOFTWARE OR THE USE OR OTHER DEALINGS IN THE SOFTWARE.

The code in `third_party/ sike` also carries the MIT license:

Copyright (c) Microsoft Corporation. All rights reserved.

Permission is hereby granted, free of charge, to any person obtaining a copy of this software and associated documentation files (the "Software"), to deal in the Software without restriction, including without limitation the rights to use, copy, modify, merge, publish, distribute, sublicense, and/or sell copies of the Software, and to permit persons to whom the Software is furnished to do so, subject to the following conditions:

The above copyright notice and this permission notice shall be included in all copies or substantial portions of the Software.

THE SOFTWARE IS PROVIDED "AS IS", WITHOUT WARRANTY OF ANY KIND, EXPRESS OR IMPLIED, INCLUDING BUT NOT LIMITED TO THE WARRANTIES OF MERCHANTABILITY, FITNESS FOR A PARTICULAR PURPOSE AND NONINFRINGEMENT. IN NO EVENT SHALL THE AUTHORS OR COPYRIGHT HOLDERS BE LIABLE FOR ANY CLAIM, DAMAGES OR OTHER

LIABILITY, WHETHER IN AN ACTION OF CONTRACT, TORT OR OTHERWISE, ARISING FROM, OUT OF OR IN CONNECTION WITH THE SOFTWARE OR THE USE OR OTHER DEALINGS IN THE SOFTWARE

Licenses for support code

Parts of the TLS test suite are under the Go license. This code is not included in BoringSSL (i.e. libcrypto and libssl) when compiled, however, so distributing code linked against BoringSSL does not trigger this license:

Copyright (c) 2009 The Go Authors. All rights reserved.

Redistribution and use in source and binary forms, with or without modification, are permitted provided that the following conditions are met:

- * Redistributions of source code must retain the above copyright notice, this list of conditions and the following disclaimer.
- * Redistributions in binary form must reproduce the above copyright notice, this list of conditions and the following disclaimer in the documentation and/or other materials provided with the distribution.
- * Neither the name of Google Inc. nor the names of its contributors may be used to endorse or promote products derived from this software without specific prior written permission.

THIS SOFTWARE IS PROVIDED BY THE COPYRIGHT HOLDERS AND CONTRIBUTORS "AS IS" AND ANY EXPRESS OR IMPLIED WARRANTIES, INCLUDING, BUT NOT LIMITED TO, THE IMPLIED WARRANTIES OF MERCHANTABILITY AND FITNESS FOR A PARTICULAR PURPOSE ARE DISCLAIMED. IN NO EVENT SHALL THE COPYRIGHT OWNER OR CONTRIBUTORS BE LIABLE FOR ANY DIRECT, INDIRECT, INCIDENTAL, SPECIAL, EXEMPLARY, OR CONSEQUENTIAL DAMAGES (INCLUDING, BUT NOT LIMITED TO, PROCUREMENT OF SUBSTITUTE GOODS OR SERVICES; LOSS OF USE,

DATA, OR PROFITS; OR BUSINESS INTERRUPTION) HOWEVER CAUSED AND ON ANY THEORY OF LIABILITY, WHETHER IN CONTRACT, STRICT LIABILITY, OR TORT (INCLUDING NEGLIGENCE OR OTHERWISE) ARISING IN ANY WAY OUT OF THE USE OF THIS SOFTWARE, EVEN IF ADVISED OF THE POSSIBILITY OF SUCH DAMAGE.

Apache License

Version 2.0, January 2004 (<http://www.apache.org/licenses/>)

TERMS AND CONDITIONS FOR USE, REPRODUCTION, AND DISTRIBUTION

0. Definitions.

"License" shall mean the terms and conditions for use, reproduction, and distribution as defined by Sections 1 through 9 of this document.

"Licensor" shall mean the copyright owner or entity authorized by the copyright owner that is granting the License.

"Legal Entity" shall mean the union of the acting entity and all other entities that control, are controlled by, or are under common control with that entity. For the purposes of this definition, "control" means (i) the power, direct or indirect, to cause the direction or management of such entity, whether by contract or otherwise, or (ii) ownership of fifty percent (50%) or more of the outstanding shares, or (iii) beneficial ownership of such entity.

"You" (or "Your") shall mean an individual or Legal Entity exercising permissions granted by this License.

"Source" form shall mean the preferred form for making modifications, including but not limited to software source code, documentation source, and configuration files.

"Object" form shall mean any form resulting from mechanical transformation or translation of a Source form, including but not limited to compiled object code, generated documentation, and conversions to other media types.

"Work" shall mean the work of authorship, whether in Source or Object form, made available under the License, as indicated by a copyright notice that is included in or attached to the work (an example is provided in the Appendix below).

"Derivative Works" shall mean any work, whether in Source or Object form, that is based on (or derived from) the Work and for which the editorial revisions, annotations, elaborations, or other modifications represent, as a whole, an original work of authorship. For the purposes of this License, Derivative Works shall not include works that remain separable from, or merely link (or bind by name) to the interfaces of, the Work and Derivative Works thereof.

"Contribution" shall mean any work of authorship, including the original version of the Work and any modifications or additions to that Work or Derivative Works thereof, that is intentionally submitted to Licensor for inclusion in the Work by the copyright owner or by an individual or Legal Entity authorized to submit on behalf of the copyright owner. For the purposes of this definition, "submitted" means any form of electronic, verbal, or written communication sent to the Licensor or its representatives, including but not limited to communication on electronic mailing lists, source code control systems, and issue tracking systems that are managed by, or on behalf of, the Licensor for the purpose of discussing and improving the Work, but excluding communication that is conspicuously marked or otherwise designated in writing by the copyright owner as "Not a Contribution."

"Contributor" shall mean Licensor and any individual or Legal Entity on behalf of whom a Contribution has been received by Licensor and subsequently incorporated within the Work.

1. Grant of Copyright License.

Subject to the terms and conditions of this License, each Contributor hereby grants to You a perpetual, worldwide, non-exclusive, no-charge, royalty-free, irrevocable copyright license to reproduce, prepare Derivative Works of, publicly display, publicly perform, sublicense, and distribute the Work and such Derivative Works in Source or Object form.

2. Grant of Patent License.

Subject to the terms and conditions of this License, each Contributor hereby grants to You a perpetual, worldwide, non-exclusive, no-charge, royalty-free, irrevocable (except as stated in this section) patent license to make, have made, use, offer to sell, sell, import, and otherwise transfer the Work, where such license applies only to those patent claims licensable by such Contributor that are necessarily infringed by their Contribution(s) alone or by combination of their Contribution(s) with the Work to which such Contribution(s) was submitted. If You institute patent litigation against any entity (including a cross-claim or counterclaim in a lawsuit) alleging that the Work or a Contribution incorporated within the Work constitutes direct or contributory patent infringement, then any patent licenses granted to You under this License for that Work shall terminate as of the date such litigation is filed.

3. Redistribution.

You may reproduce and distribute copies of the Work or Derivative Works thereof in any medium, with or without modifications, and in Source or Object form, provided that You meet the following conditions:

- (a) You must give any other recipients of the Work or Derivative Works a copy of this License; and
- (b) You must cause any modified files to carry prominent notices stating that You changed the files; and
- (c) You must retain, in the Source form of any Derivative Works that You distribute, all copyright, patent, trademark, and attribution notices from the Source form of the Work, excluding those notices that do not pertain to any part of the Derivative Works; and
- (d) If the Work includes a "NOTICE" text file as part of its distribution, then any Derivative Works that You distribute must include a readable copy of the attribution notices contained within such NOTICE file, excluding those notices that do not pertain to any part of the Derivative Works, in at least one of the following places: within a NOTICE text file distributed as part of the Derivative Works; within the Source form or documentation, if provided along with the Derivative Works; or, within a display generated by the Derivative Works, if and wherever such third-party notices normally appear. The contents of the NOTICE file are for informational purposes only and do not modify the License. You may add Your own attribution notices within Derivative Works that You distribute, alongside or as an addendum to the NOTICE text from the Work, provided that such additional attribution notices cannot be construed as modifying the License.

You may add Your own copyright statement to Your modifications and may provide additional or different license terms and conditions for use, reproduction, or distribution of Your modifications, or for any such Derivative Works as a whole, provided Your use, reproduction, and distribution of the Work otherwise complies with the conditions stated in this License.

4. Submission of Contributions.

Unless You explicitly state otherwise, any Contribution intentionally submitted for inclusion in the Work by You to the Licensor shall be under the terms and conditions of this License, without any additional terms or conditions. Notwithstanding the above, nothing herein shall supersede or modify the terms of any separate license agreement you may have executed with Licensor regarding such Contributions.

5. Trademarks.

This License does not grant permission to use the trade names, trademarks, service marks, or product names of the Licensor, except as required for reasonable and customary use in describing the origin of the Work and reproducing the content of the NOTICE file.

6. Disclaimer of Warranty.

Unless required by applicable law or agreed to in writing, Licensor provides the Work (and each Contributor provides its Contributions) on an "AS IS" BASIS, WITHOUT WARRANTIES OR CONDITIONS OF ANY KIND, either express or implied, including, without limitation, any warranties or conditions of TITLE, NON-INFRINGEMENT, MERCHANTABILITY, or FITNESS FOR A PARTICULAR PURPOSE. You are solely responsible for determining the appropriateness of using or redistributing the Work and assume any risks associated with Your exercise of permissions under this License.

7. Limitation of Liability.

In no event and under no legal theory, whether in tort (including negligence), contract, or otherwise, unless required by applicable law (such as deliberate and grossly negligent acts) or agreed to in writing, shall any Contributor be liable to You for damages, including any direct, indirect, special, incidental, or consequential damages of any character arising as a result of this License or out of the use or inability to use the Work (including but not limited to damages for loss of goodwill, work stoppage, computer failure or malfunction, or any and all other commercial damages or losses), even if such Contributor has been advised of the possibility of such damages.

8. Accepting Warranty or Additional Liability.

While redistributing the Work or Derivative Works thereof, You may choose to offer, and charge a fee for, acceptance of support, warranty, indemnity, or other liability obligations and/or rights consistent with this License. However, in accepting such obligations, You may act only on Your own behalf and on Your sole responsibility, not on behalf of any other Contributor, and only if You agree to indemnify, defend, and hold each Contributor harmless for any liability incurred by, or claims asserted against, such Contributor by reason of your accepting any such warranty or additional liability.

END OF TERMS AND CONDITIONS

Suprema
SECURITY & BIOMETRICS

Suprema Inc.

17F Parkview Tower, 248, Jeongjail-ro, Bundang-gu, Seongnam-si, Gyeonggi-do, 13554, Rep. of KOREA

電話: +82 31 783 4502 | Fax: +82 31 783 4503 | お問い合わせ: sales_sys@supremainc.com



Supremaのグローバル支社の詳細については、
QRコードをスキャンして以下のWebページにアクセスしてください。
<http://www.supremainc.com/en/about/contact-us.asp>

© 2024 Suprema, Inc. 本書に記載されている Suprema および Suprema 社の製品名および番号は、Suprema, Inc. の登録商標です。Suprema 社以外のすべてのブランドおよび製品名は、それぞれの企業の商標または登録商標です。製品の外観、ビルドステータスおよび/または仕様は、予告なく変更されることがあります。